



Model AMSO35 shown

Heavy Volume

Amana® Commercial Model AMSO35

Power Output

- 3500 watts of power.
- 11 power levels for consistent, delicious results for frozen, refrigerated and fresh foods - from the freezer to table in minutes.
- Unique method of energy distribution provides superior and even heating throughout the cavity.

Easy to Use

- Ample 1.6 cubic ft. (45 liter) cavity accommodates two standard 4" deep full size pans.
- Up to 100 programmable menu items can be used to simplify cooking and ensures consistent results.
- USB port compatible with standard flash drives, updates programming in seconds.
- Four stage cooking options with one-touch programming. Reduces prep time, labor and food waste while providing consistent results.
- Controls are user friendly and require minimal training.
- Quantity pad calculates the proper cook times for two servings.
- Automatic voltage sensor for easy installation.
- Transparent door and lit interior for monitoring without opening the door.
- Interior ceramic shelf is recessed to reduce plate-to-shelf edge impact and keep spills contained.

Easy to Maintain

- Stainless steel exterior and interior for easy cleaning and a professional look.
- Constructed to withstand the foodservice environment.
- Magnetic front air filter for easy removal and cleaning.
- Clean filter reminder to protect oven components.
- Backed by the ACP, Inc. 24/7 ComServ Support Center, 866-426-2621.
- ETL Listed

Heavy Volume

This category of microwave is ideal for...

Applications:

- Schools
- Healthcare Facilities
- Buffets
- Cafeterias
- Stadiums
- Supermarkets
- Fast Casual Restaurant

Defrost:

- Defrosts most frozen food products

Throughput Potential:

- 10 lb. (4.5 kg) baby red potatoes, 5 per hour
- 8 lb. (3.5 kg) frozen vegetables, 6 per hour
- 2 lb. (1 kg) shrimp, 24 per hour

All ACP, Inc. commercial ovens are backed by our Culinary Center. Call us with any question regarding food preparation, menu development and cooking times. 866-426-2621.



Amana® Commercial Model AMSO35 | Heavy Volume

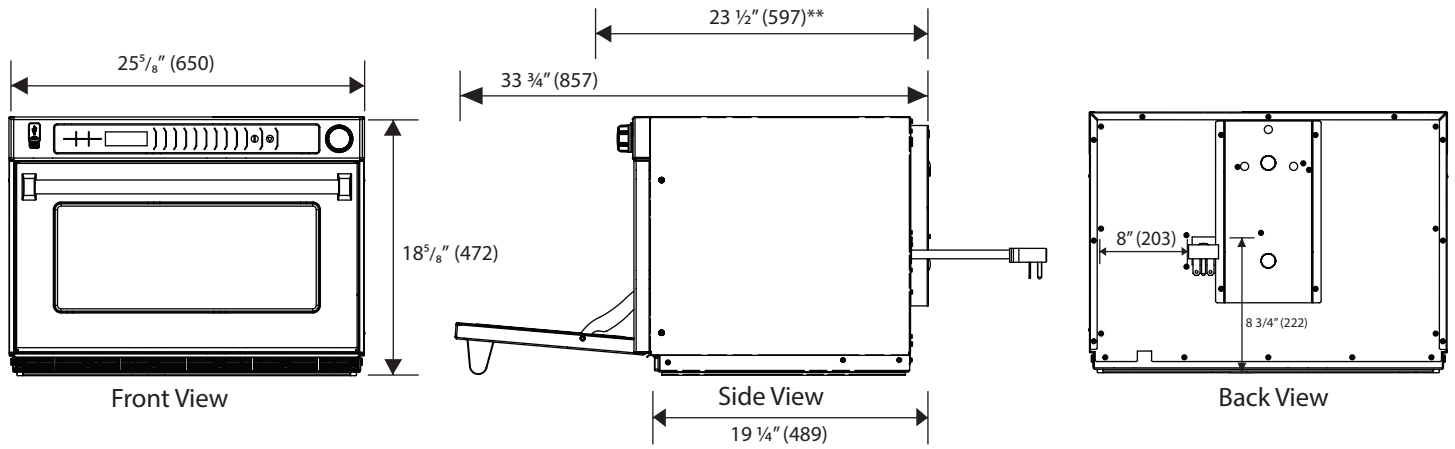

Installation Clearances - Top: 2" (51), Sides: 1" (25), Back: None

Drawings available from KCL CADlog - techs@kclcad.com

Specification #:

Specifications	
Model	AMSO35 728028376791
Configuration	Countertop
Control System	Touch w/ dial
Programmable Control Pads	10
Settings Programmable	100
Max. Cooking Time	60 minutes
Power Levels	11
Defrost	Yes, power level 2
Dial Time Entry	Yes
Time Entry Option	Yes
Microwave Distribution	Top and bottom antennas
Magnetrons	4
Display	LCD
Stage Cooking	Yes, 4
Interior Light	Yes, LED
Door Opening	Pull down
Door Construction	Window
Latch Number	2
Window Material	Glass
Air Filter w/Reminder	Yes
Stackable	Yes
Signal	Yes
Automatic Voltage Sensor	Yes
Multiple Portion Setting	Yes, x2
Exterior Dimensions	H 18 5/8" (472) W 25 5/8" (650) D** 23 1/2" (597)
Cavity Dimensions	H 9 7/8" (251) W 21" (535) D 13" (330)
Door Depth	33 3/4" (857), drop down door
Usable Cavity Space	1.6 cubic ft. (45 liter)
Exterior Finish	Stainless steel
Interior Finish	Stainless steel with recessed ceramic tray and removable shelf
Power Consumption	5100 W
Power Output*	3500 W* Microwave
Power Source	208/240V, 60 Hz, 30A single phase
Plug Configuration / Cord	NEMA 6-30 5 ft. (1.5m)
Frequency	2450 MHz
Product Weight	146 lb. (66 kg)
Ship weight (approx.)	161 lb. (73 kg)
Shipping Carton Size	H 22 1/4" (565) W 30 1/4" (768) D 26 1/4" (667)

AIA File #:

Specifications

Commercial microwave 10 touch pad control panel shall be programmable with the ability to program up to 100 menu items and shall have automatic cooking capability for up to two servings. Cooking timer shall be no more than 60 minutes, countdown style with a time entry option and an adjustable end of cycle audible signal. LCD display shall be a backlit. There shall be 11 power levels, 4 cooking stages and defrost mode at 20% power. Microwave output shall be 3500 watts distributed by four magnetrons, each with a rotating antenna to provide even heating throughout the cavity. An automatic voltage sensor shall accommodate both 208 and 240 volts. Heavy duty door shall have a tempered glass window and a pull down door for easy access. An interior light shall facilitate monitoring without opening the door. The large 1.6 cubic ft. (45 liter) cavity shall accommodate two standard 4" (102) deep full size pans. Interior ceramic shelf shall be recessed to reduce plate-to-shelf edge impact. Oven shall have a stainless steel interior and exterior and be stackable to save counter and shelf space. Oven shall have a "clean filter" reminder feature. Microwave oven shall comply with standards set by the U.S Department of Health and Human Services, UL for safety and NSF for sanitation.

Service

All products are backed by the ACP, Inc. 24/7 ComServ Support Center.

Warranty

Warranty Certificate for this product can be found on the ACP, Inc. website at: www.acpsolutions.com/warranty



Measurements in () are millimeters

* IEC 60705 Tested

** Includes handle