



# Instruction Manual

## Olde New Orleans Block Ice Shaver

Model No. 1087DC







**GOLD MEDAL® PRODUCTS CO.**



10700 Medallion Drive, Cincinnati, Ohio 45241-4807 USA







# SAFETY PRECAUTIONS



	 <b>DANGER</b>
	<p>Machine must be properly grounded to prevent electrical shock to personnel. Failure to do so could result in serious injury, or death. DO NOT immerse any part of this equipment in water. DO NOT use excessive water when cleaning. Keep cord and plug off the ground and away from moisture. Always unplug the equipment before cleaning or servicing. Make sure all machine switches are in the OFF position before plugging the equipment into the receptacle.</p> <p>008_051514</p>

	 <b>DANGER</b>
	<p>Improper installation, adjustment, alteration, service, or maintenance can cause property damage, injury, or death. Any alterations to this equipment will void the warranty and may cause a dangerous condition. This appliance is not intended to be operated by means of an external timer or separate remote-control system. NEVER make alterations to this equipment. Read the Installation, Operating, and Maintenance Instructions thoroughly before installing, servicing, or operating this equipment.</p> <p>014_020416</p>

	 <b>WARNING</b>
	<p>This machinery contains sharp blades. Keep hands and body parts clear at all times.</p> <p>037_103114</p>

	 <b>WARNING</b>
	<p>NEVER put your fingers into the shaver body (the goose-neck, ice chute, or hopper). Serious injury may occur.</p> <p>017_103114</p>

	 <b>WARNING</b>
	<p>ALWAYS wear safety glasses when servicing this equipment.</p> <p>010_010914</p>



	 <b>WARNING</b>
	<p>No user serviceable parts inside. Refer servicing to qualified service personnel.</p> <p>011_051514</p>





## SAFETY PRECAUTIONS (continued)

	 <b>WARNING</b>
	Read and understand operator's manual and all other safety instructions before using this equipment. To order copies of the operator's manual go to <a href="http://gmpopcorn.com">gmpopcorn.com</a> or write to Gold Medal Products Co., 10700 Medallion Drive, Cincinnati, OH 45241 USA 1-(800)-543-0862

022\_060215

	 <b>WARNING</b>
	DO NOT allow direct contact of this equipment by the public when used in food service locations. Only personnel trained and experienced in the equipment operation may operate this equipment. Carefully read all instructions before operation.

012\_010914

	 <b>WARNING</b>
	This machine is NOT to be operated by minors.

007\_010914

**Note:** Improvements are always being made to Gold Medal's equipment. This information may not be the latest available for your purposes. It is critical that you call Gold Medal's Technical Service Department at 1-800-543-0862 for any questions about your machine operations, replacement parts, or any service questions. (Gold Medal Products Co. does not assume any liability for injury due to careless handling and/or reckless operation of this equipment.)

# INSTALLATION INSTRUCTIONS

## Inspection of Shipment

After unpacking, check thoroughly for any damage which may have occurred in transit. Claims should be filed immediately with the transportation company. The warranty does not cover damage that occurs in transit, or damage caused by abuse, or consequential damage due to the operation of this machine, since it is beyond our control (reference warranty in back of manual).

## Manual

Read and understand the operator's manual and all other safety instructions before using this equipment. To order copies of the operator's manual go to [gmpopcorn.com](http://gmpopcorn.com) or write to Gold Medal Products Co., 10700 Medallion Drive, Cincinnati, OH 45241 USA 1-(800)-543-0862.

## Items Included with this Unit



## Setup

This unit has been tested at the factory.

1. Remove all packaging and tape prior to operation.
2. Place unit on a sturdy, level base which can withstand accidental dripping of water and ice.
3. Connect the drain hose to funnel excess water to floor drain or basin tub. Drained water is not intended for human consumption.
4. After setup, the unit should be cleaned prior to use (see Care and Cleaning section of this manual).



## Special Features

1. Model #1087DC uses block ice approximately 5" x 5" x 12" long.
2. Snow texture can be adjusted easily with varying the feed pressure applied to pusher lever arm.
3. Cutter Head is equipped with three blades for rapid shaving.
4. Safety switch is installed to prevent operation of cutter head while shaver door is in an open position.
5. Circuit Breaker Reset Switch in the event that a motor overheats.

## Electrical Requirements

The following power supply must be provided:

**1087DC:** 12 Volts DC

Customer must supply 12 volt battery for proper machine operation.

Make sure to follow all safety precautions provided by the battery manufacturer.

## Before You Connect Power to the Machine

1. Make sure all machine switches are in the OFF position before connecting to the battery.
2. Cables must be attached to the proper polarity. Black is "+" positive; white is "-" negative.  
**Note:** If poles are reversed machine will not shave ice.
3. Install the unit in a level position.

# OPERATING INSTRUCTIONS

## Controls and Their Functions

**POWER SWITCH** – Turns on the power to the shaver motor.

**DOOR SWITCH** – A safety precaution which prevents machine operation when door is open.

**CIRCUIT BREAKER** – Protects the motor from overheating (locked rotor/mechanical failure to start). Manual Reset, push black button to reset.

**TOP HAND WHEEL** – Applies pressure to the block ice loaded into the machine.

**PRESSURE LEVER** – Pressure applied on this lever determines the fineness or coarseness of the shaved ice.

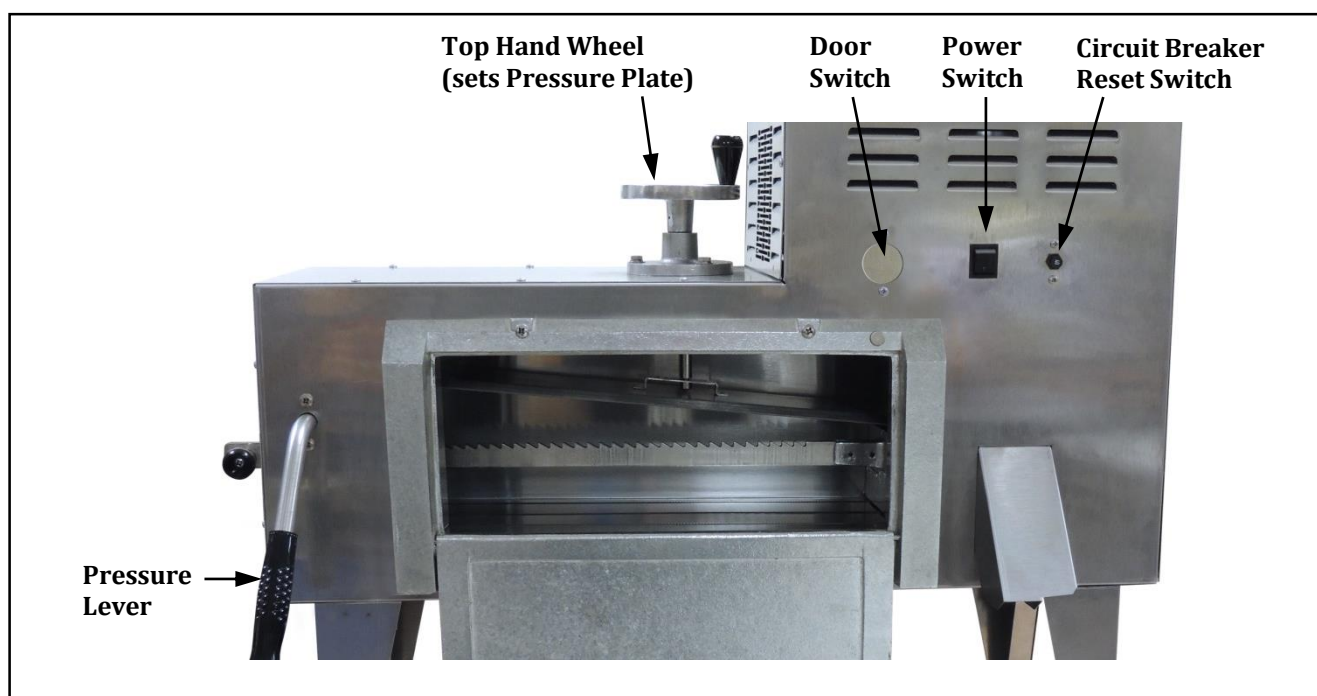

## Using Your Machine

1. Allow ice to soften before use. When properly softened, ice will appear clear and not frosted.
2. Lower cover door and load ice block. Set pressure plate by turning the top hand wheel (failure to set pressure plate causes excessive load on driveline). After pressure is set close the door.

**NOTE:** The machine will not to operate if the door is open.

3. Place ice pan directly below ice chute and engage power switch. With left hand on pressure lever, force ice into shaver head. The amount of pressure applied at this point will determine the fineness or coarseness of the shaved ice.

The last inch or so of the block of ice being shaved will typically break apart.



## Care and Cleaning

	<b>⚠ DANGER</b>
	Machine must be properly grounded to prevent electrical shock to personnel. <b>DO NOT immerse in water.</b> Always unplug the equipment before cleaning or servicing. <small>025_020314</small>

	<b>⚠ WARNING</b>
	This machinery contains sharp blades. Keep hands and body parts clear at all times. <small>037_103114</small>

Good sanitation practice demands that all food preparation equipment be cleaned regularly (only use non-toxic, food grade cleaners). A clean looking, well-kept machine is one of the best ways of advertising your product.

Follow the directions below to clean and sanitize the unit after each day of use.

1. With the machine OFF, unplug the unit before attempting to clean.
2. Empty water from pans and clean using appropriate cleaners for the type of machine; review all manufacturer's instructions and warnings on cleaning product prior to use.

**DO NOT** use oven cleaners or abrasive materials as they will damage parts of the machine.

**DO NOT** use Ammonia cleaners, they will damage plastic panels.

# Troubleshooting

## Machine Does Not Operate When the Power Switch is Engaged

Check that door is closed; machine will not operate if the door is open.

## Block Ice Will Not feed into the Unit

Check the ratchet orientation; ratchet must be positioned inward (as shown below) for the block ice to feed properly.

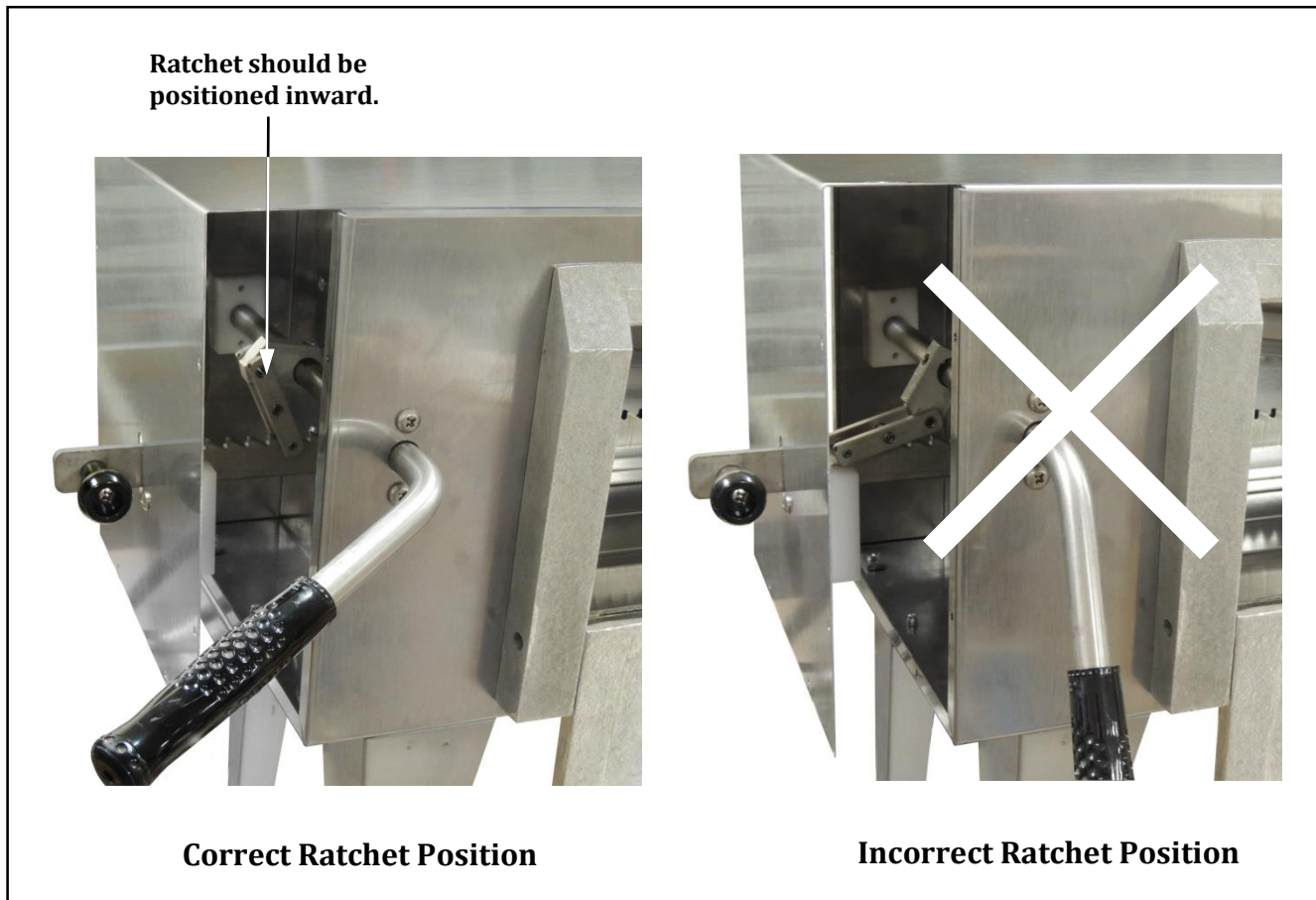







# MAINTENANCE INSTRUCTIONS

	<b>⚠ DANGER</b>
	<p>Machine must be properly grounded to prevent electrical shock to personnel. Failure to do so could result in serious injury, or death. DO NOT immerse any part of this equipment in water. DO NOT use excessive water when cleaning. Keep cord and plug off the ground and away from moisture. Always unplug the equipment before cleaning or servicing. Make sure all machine switches are in the OFF position before plugging the equipment into the receptacle.</p> <p>008_051514</p>

	<b>⚠ DANGER</b>
	<p>Improper installation, adjustment, alteration, service, or maintenance can cause property damage, injury, or death. Any alterations to this equipment will void the warranty and may cause a dangerous condition. This appliance is not intended to be operated by means of an external timer or separate remote-control system. NEVER make alterations to this equipment. Read the Installation, Operating, and Maintenance Instructions thoroughly before installing, servicing, or operating this equipment.</p> <p>014_020416</p>

	<b>⚠ WARNING</b>
	<p>No user serviceable parts inside. Refer servicing to qualified service personnel.</p> <p>011_051514</p>

	<b>⚠ CAUTION</b>
	<p>THE FOLLOWING SECTIONS OF THIS MANUAL ARE INTENDED ONLY FOR QUALIFIED SERVICE PERSONNEL WHO ARE FAMILIAR WITH ELECTRICAL EQUIPMENT. THESE ARE NOT INTENDED FOR THE OPERATOR.</p> <p>027_010914</p>



## Installing New Shaver Blades

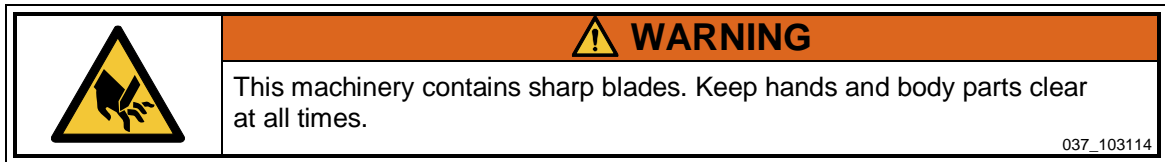

The section describes the procedure to replace the shaver blades. ALWAYS turn the machine OFF and unplug unit from the power supply prior to blade inspection or replacement. Use a flashlight to examine the blades in the shaver body. If the blades appear to be nicked or bent, then the blades should be replaced.

Follow this procedure:

1. Disconnect the main power supply cord from the battery.
2. Remove the belt guard cover by removing the (16) 8-32 screws.
3. Remove the drive belt from the drive motor and cutter head; first loosen the Belt Tensioner using a 9/16" box wrench, then use a large screw driver to wedge and rotate the belt out of the pulley groove.
4. Remove the (4) 1/4-20 bolts securing the cutter into place. The cutter head can now be removed.
5. Remove 8" diameter pulley by loosening (but do not remove) 5/16-18 set screw, and pull the pulley from the cutter head shaft.
6. **DO NOT lose the shaft key; this must be reset into place when reassembling the cutter head.**
7. Remove the snap ring from the shaft using a snap ring pliers, and remove thrust washer(s) if present. Set these aside for reuse when reassembling the cutter head.
8. The cutter head housing can now be pulled from the cutter head shaft.
9. Remove the blades from the cutter head (the blades may be re-sharpened).
10. Position new blades on cutter head and insert blade mounting screws until finger tight.
11. Set the blade height to .050" using a height gauge (thickness of a dime), see illustration on next page. Make sure the blade height is even across the shaver head.
12. Tighten the blade mounting screws completely. Check the blade height again to ensure the blades did not move while tightening the screws.
13. Reassemble in reverse order using the steps above as reference.

**Set top of blade flush with height gauge, as shown below:**



**Shaver Head with  
Height Gauge .050"**  
(thickness of a dime)

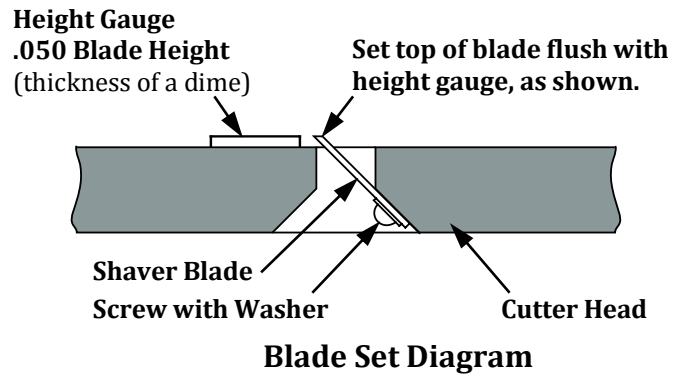



---

## ORDERING SPARE PARTS

1. Identify the needed part by checking it against the photos, illustrations, and/or parts list.
2. Use only approved replacement parts when servicing this unit.
3. When ordering, please include part number, part name, and quantity needed.
4. Please include your model number, serial number, and date of manufacture (located on the machine nameplate/data plate) with your order.
5. Address all parts orders to:

Parts Department  
Gold Medal Products Co.  
10700 Medallion Drive  
Cincinnati, Ohio 45241-4807

Or, place orders by phone or online:

Phone: (800) 543-0862  
(513) 769-7676  
Fax: (800) 542-1496  
(513) 769-8500  
E-mail: [info@gmpopcorn.com](mailto:info@gmpopcorn.com)  
Web Page: [gmpopcorn.com](http://gmpopcorn.com)



## Cabinet Exterior – Parts Breakdown

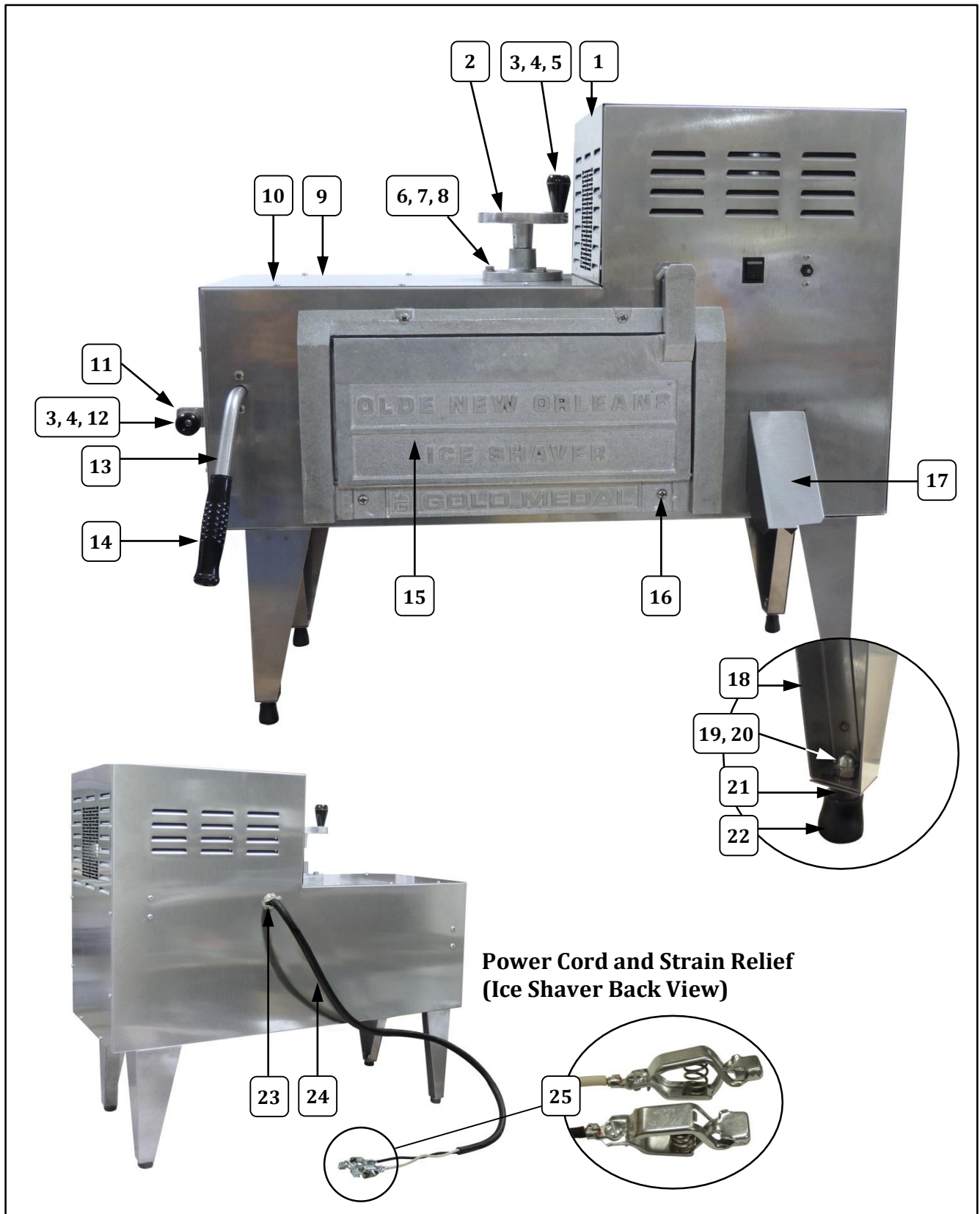



## Cabinet Exterior – Parts List

Item	Part Description	Part No.
		1087DC
1	RH COVER PLATE 1087NS	42267
2	HANDWHEEL ASSEMBLY 1087 (complete Handwheel Assy - includes knob)	12240
3	KNOB HANDWHEEL	12368
4	1/4-20 X 2 PAN HD PH M/S	12384
5	TUBE HANDWHEEL PIVOT	12369
6	1/4-20 X 3/4 HEX CAP 18-8	12515
7	1/4 SPRING LOCK WASHER	12707
8	FLAT WASHER 1/4 STAINLESS	87261
9	LH COVER WELDMENT 1087NS	42103
10	8-32 X 1/2 PH PAN T/S	87245
11	ICE PUSHER ASSEMBLY 1087	12568
12	1/4-20 HEX NUT (holds Ice Pusher Knob)	12706
13	FEED LEVER	12564
14	GRIP FOR .625 SHAFT	12561
15	DOOR ASSEMBLY	12534
16	1/4-20 X 1 1/4 PH PAN MS	51030
17	ICE CHUTE WELDMENT 1087NS	42426
18	LEG WELDMENT 1087NS	42502
19	1/4-20 LOCKING ACORN NUT	40786
20	1/4-20X3/4 SOCKET HD BOLT	12431
21	GLIDE FOOT .781 LENGTH	42514
22	CRUTCH TIP BLACK 70 DURO	49123
23	STRAIN RELIEF T&B #3303	89017
24	POWER CORD ASSY 1087DC	101053
25	CLIP ON BATTERY CONNECTION	73112



## Unit Controls - Switches

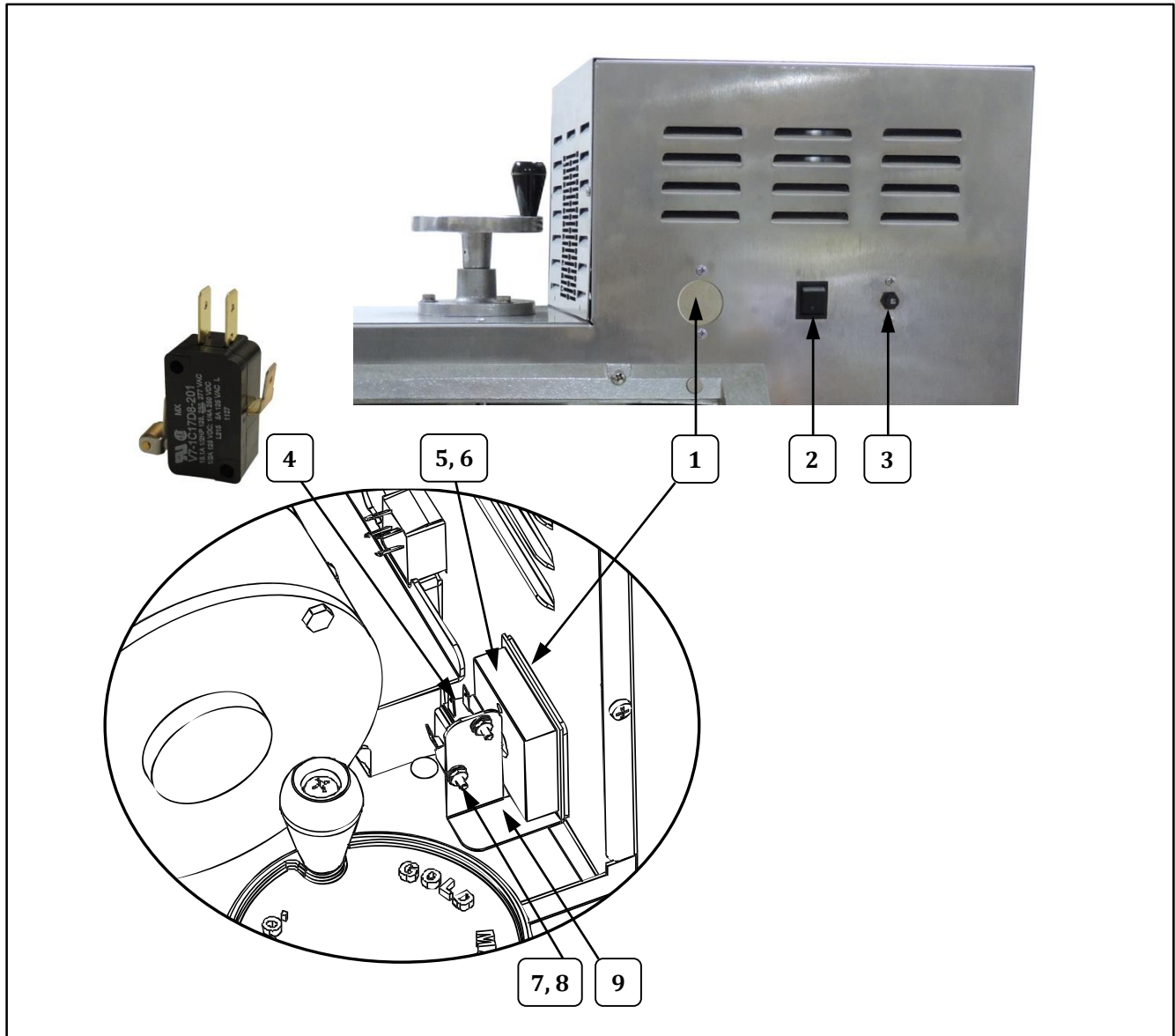

Item	Part Description	Part No.
		1087DC
1	SAFETY SWITCH MAGNET COVER	42574
2	SWITCH, ROCKER DPST	55395
3	CIRCUIT BREAKER	22037
4	DOOR SAFETY SWITCH	12116
5	MAGNET MTG BLOCK	42573
6	MAGNET 1/2IN OD X 1/2IN T	12078
7	4-40 X 3/4 PH PAN 18-8 MS	12186
8	4-40 HX HD NUT STAINLESS	12386
9	SAFETY SWITCH MOUNTING BRACKET	42522



## Cabinet Interior

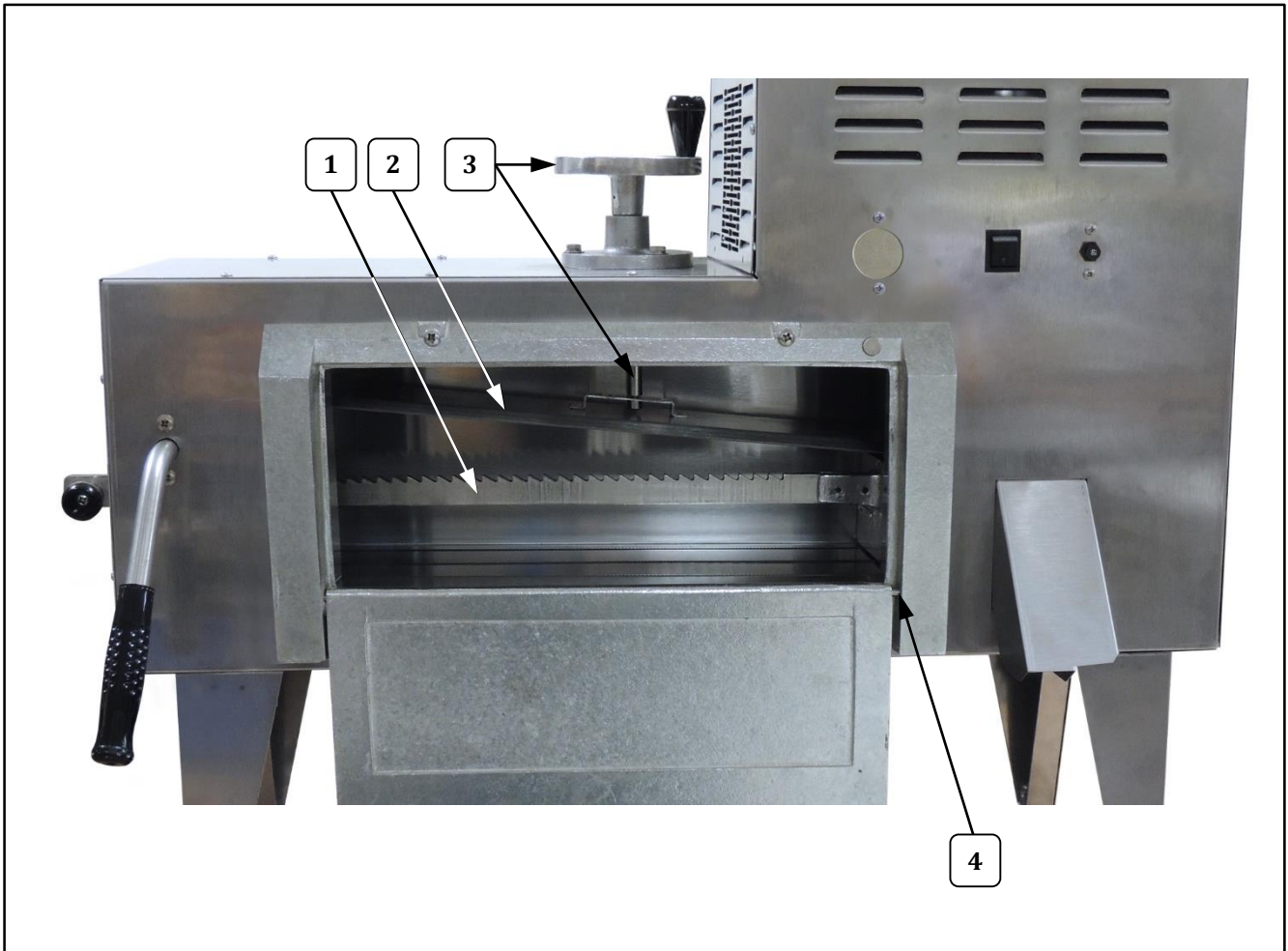

Item	Part Description	Part No.
		1087DC
1	ICE PUSHER ASSEMBLY 1087	12568
2	ICE RETAINER WLDMNT	12299
3	HANDWHEEL ASSEMBLY	12240
4	1/4 X 5/8 SHLDER BOLT SS	12693



## Cabinet Interior – Ratchet End

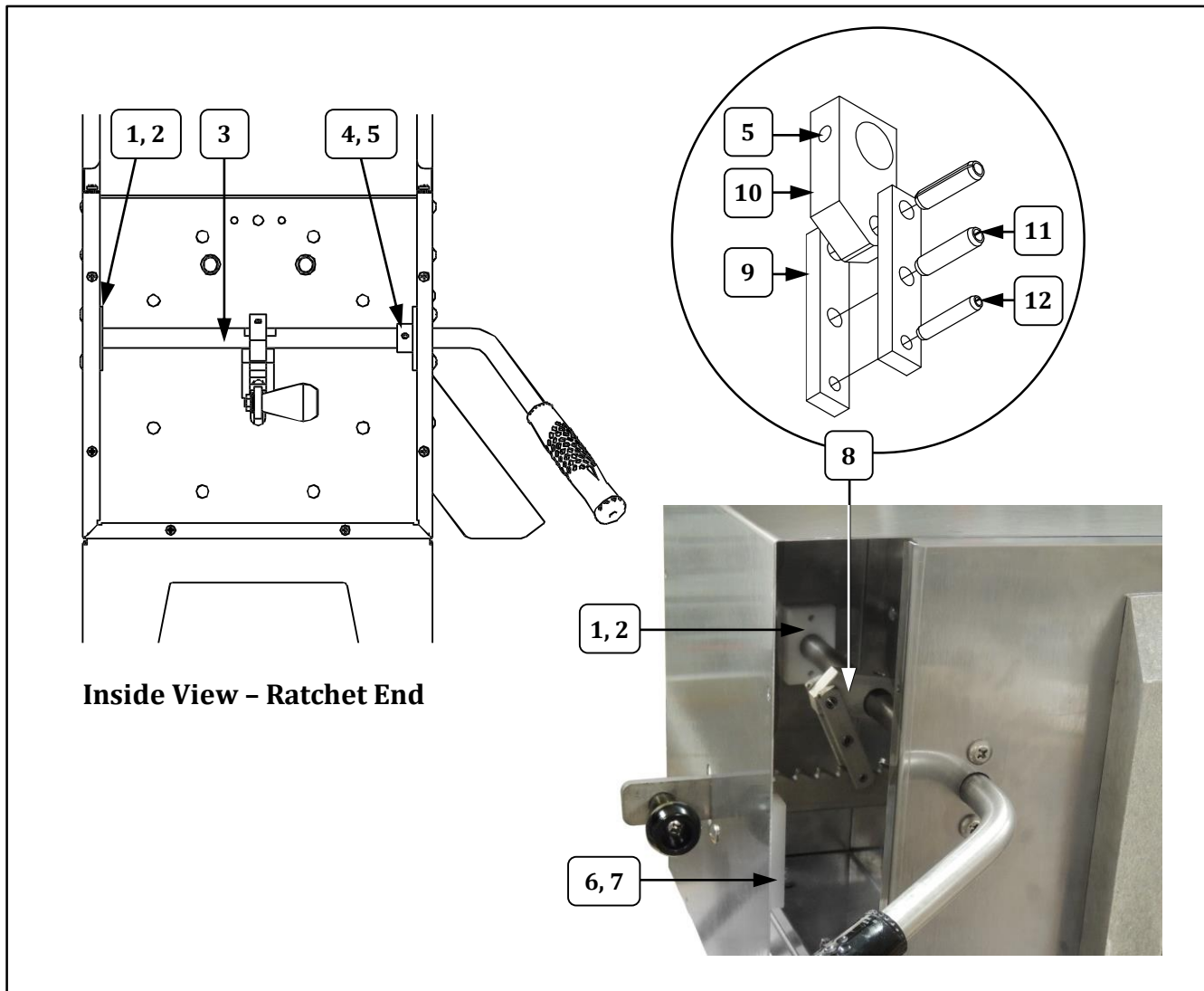

Item	Part Description	Part No. 1087DC
1	FEED LEVER SUPPORT	12562
2	12-14 X 1/2 TYPE-B SMS (screw for Feed Lever Support)	42937
3	FEED LEVER	12564
4	SET COLLAR .625" SHAFT	12566
5	SET SCREW 1/4-20 X 3/16	47751
6	RATCHET RAIL SUPPORT	12259
7	10 X 1/2 TYPE B SMS (screw for Ratchet Rail Support)	42828
8	RATCHET ASSEMBLY	12422
9	RATCHET MECH PART B 1087	12256
10	RATCHET MECH PART A 1087	12563
11	SPRING PIN 1/4 X 1	12462
12	SPRING PIN 3/16 X 1	12460





## Cabinet Interior – Motor View – Parts List

Item	Part Description	Part No.
		1087DC
1	12V DC MOTOR	22041
2	5/16-18 x 3/4 HEAD HEAD	12582
3	5/16 FLAT WASHER, 18-8	12184
4	5/16 SPRING LOCK WASHER	12705
5	5/16-18 STAINLESS HEX NUT	38388
6	MOTOR PLATE 1087DC	101051
7	2.5" PULLEY .625 BORE	12228
8	AX33 DRIVE BELT	42513
9	8" PULLEY .625 BORE W/KEY	12246
10	KEY .187 X .187 X 3/4	12509
11	* SHAVER HEAD ASSY 1087NS	41146
12	BELT TENSIONER ASSEMBLY	42503
13	IDLER TENSIONER PULLEY ASSEMBLY	42509
14	3/8-16 HEX NUT	46000
15	3/8-16 X 2 HEX HD BOLT	12470
16	BELT TENSIONER WELDMENT	42244
17	1/4-20 X 3/4 HEX CAP 18-8	12515
18	BELT TNSR GUIDE 1087NS (Spacer)	42603
19	1/4 SPRING LOCK WASHER	12707
20	1/4-20 HEX NUT, S.S.	12706
21	RELAY SPST 30A 12VDC	55432



# Shaver Head Assembly – Parts Breakdown

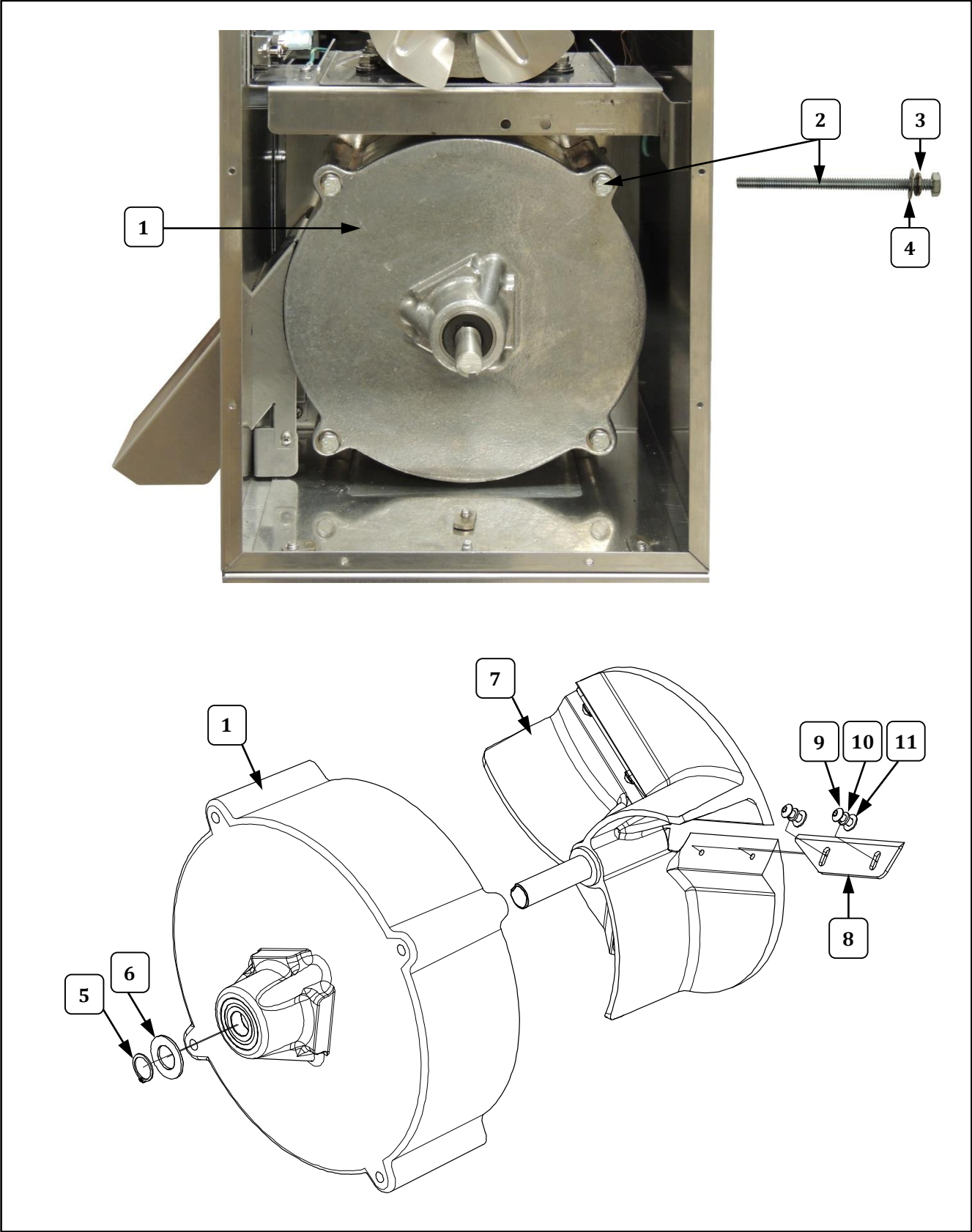

## Shaver Head Assembly – Parts List

Item	Part Description	Part No.
		1087DC
1	IMPELLER HOUSING ASSEMBLY	41110
2	HEX HD BOLT 1/4-20 X 4	42530
3	1/4 SPRING LOCK WASHER	12707
4	FLAT WASHER 1/4 STAINLESS	87261
5	EXTERNAL SNAP RING	12497
6	THRUST WASHER SET F 5/8 IN SHF	39029
7	SHAVER HEAD ASSEMBLY	41146
8	SHAVER BLADE 1087NS (3 required for each shaver head. All replacement blades include a Height Gauge.)	41310
9	10-24 X 1/2 CAP SCREW	12467
10	#10 S.S. MED LOCK WASHER	12493
11	#10 FLAT WASHER ST. STL	12178

## Accessories



Item	Part Description	Part No.
		1087DC
1	DRAIN PAN W/FITTING	12464
2	DRAIN HOSE 3/8 ID 1/16 W (uses 3 ft.)	22034
3	HOSE CLAMP W/SCREW	41163
4	ICE PAN	29004
5	BLOCK ICE MOLD	1487
6	ICE PICK	22020
7	8 OZ SNO-KONE® DIPPER	1068



# Wiring Diagram

## Model No. 1087DC

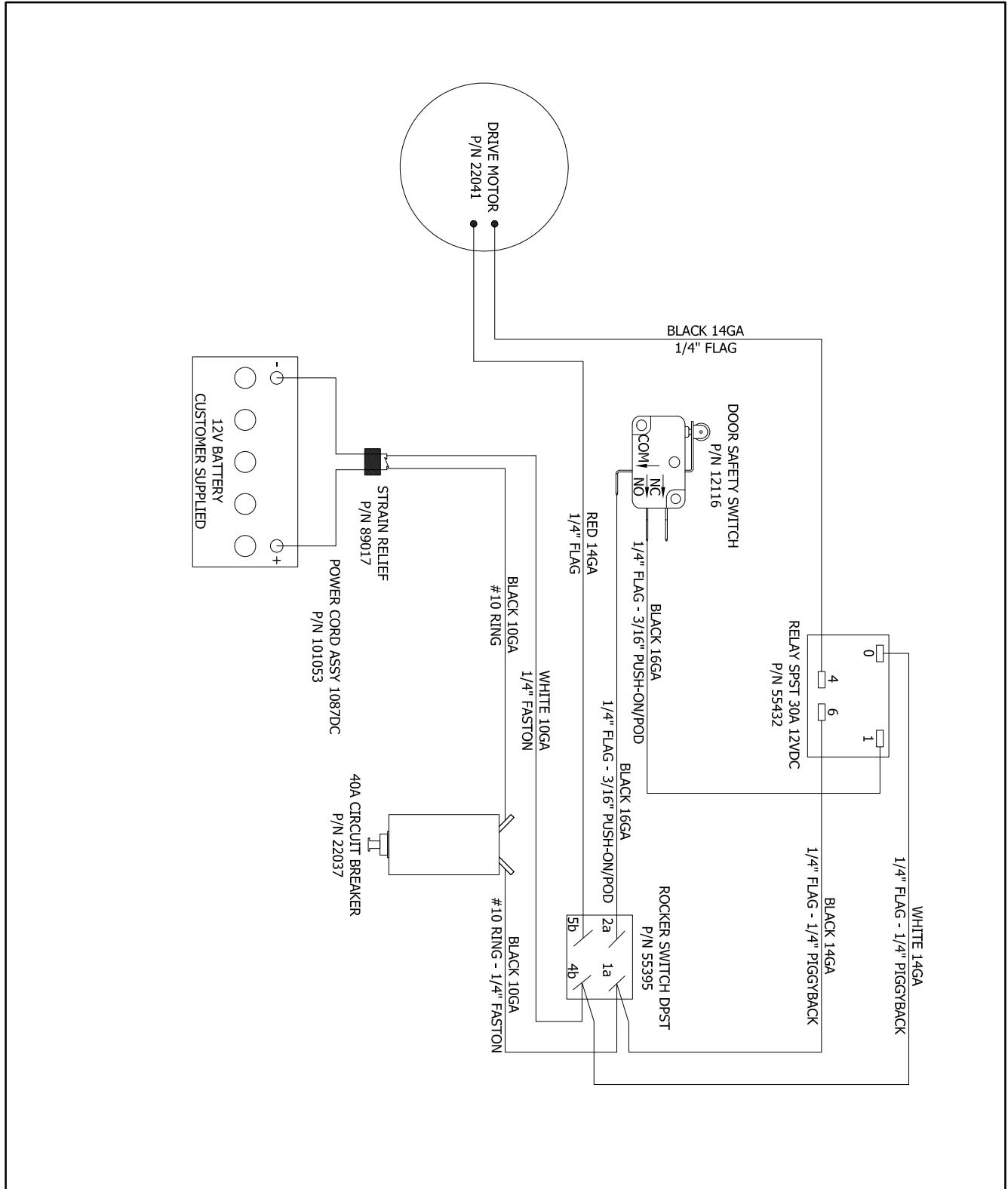



## WARRANTY

Gold Medal Products Co. warrants to the original purchaser each item of its manufacture to be free of defects in workmanship and material under normal use and service. Gold Medal Products Co.'s obligation under this warranty is limited solely to repairing or replacing parts, f.o.b. Cincinnati, Ohio, which in its judgment are defective in workmanship or material and which are returned, freight prepaid, to its Cincinnati, Ohio factory or other designated point. Except for "Perishable Parts" on specific machines, the above warranty applies for a period of two (2) years from the date of original sale to the original purchaser of equipment when recommended operating instructions and maintenance procedures have been followed. These are packed with the machine. Parts warranty is two (2) years, labor is six (6) months.

THIS WARRANTY IS IN LIEU OF ALL OTHER WARRANTIES EXPRESSED OR IMPLIED, AND OF ALL OTHER OBLIGATIONS OR LIABILITIES ON OUR PART, INCLUDING THE IMPLIED WARRANTY OF MERCHANTABILITY. THERE ARE NO WARRANTIES WHICH EXTEND BEYOND THE DESCRIPTION ON THE FACE HEREOF. In no event shall Gold Medal Products Co. be liable for special, incidental or consequential damages. No claim under this warranty will be honored if the equipment covered has been misused, neglected, damaged in transit, or has been tampered with or changed in any way. No claim under this warranty shall be honored in the event that components in the unit at the time of the claim were not supplied or approved by Gold Medal Products Co. This warranty is effective only when electrical items have been properly attached to city utility lines only at proper voltages. This warranty is not transferable without the written consent of Gold Medal Products Co.

The term "Original Purchaser" as used in this warranty shall be deemed to mean that person, firm, association, or corporation who was billed by the GOLD MEDAL PRODUCTS CO., or their authorized distributor for the equipment.

THIS WARRANTY HAS NO EFFECT AND IS VOID UNLESS THE ORIGINAL PURCHASER FIRST CALLS GOLD MEDAL PRODUCTS CO. AT 1-800-543-0862 TO DISCUSS WITH OUR SERVICE REPRESENTATIVE THE EQUIPMENT PROBLEM, AND, IF NECESSARY, FOR INSTRUCTIONS CONCERNING THE REPAIR OR REPLACEMENT OF PARTS.

*NOTE: This equipment is manufactured and sold for commercial use only.*



**GOLD MEDAL PRODUCTS CO.**

10700 Medallion Drive, Cincinnati, Ohio 45241-4807 USA

[gmpopcorn.com](http://gmpopcorn.com)

Phone: (800) 543-0862      Fax: (800) 542-1496  
(513) 769-7676              (513) 769-8500