

6 oz. Kettle Poppers

With / Love My Popper Kettle

Popcorn Machine Instruction Manual

Models: 1871,2660,2661



 **GOLD MEDAL**®

FUNFOOD EQUIPMENT & SUPPLIES

Cincinnati, OH 45241-4807 USA

SAFETY PRECAUTIONS



⚠ DANGER

Machine must be properly grounded to prevent electrical shock to personnel.
Do NOT immerse the kettle, warmer, or any other part of this equipment in water.
Always unplug the equipment before cleaning or servicing.



⚠ WARNING

Any alterations to this equipment will void the warranty and may cause a dangerous situation. NEVER make alterations to the equipment.
Make sure all machine switches are in the OFF position before plugging the equipment into a receptacle.



⚠ WARNING

To avoid serious burns, do NOT touch the kettle while it is hot.



⚠ WARNING

Adequate eye protection must be used when servicing this equipment to prevent the possibility of injury.



⚠ CAUTION

This equipment is designed and sold for commercial use only. This equipment is not to be used by the consumer in home use. Do not allow direct contact of this equipment by the public when used in food service locations. Only personnel trained and experienced in the equipment operation may operate this equipment.
Carefully read all installation instructions before operating the equipment.

NOTE

The information, specifications and illustrations contained in this manual represent the latest data available at time of publication. Right is reserved to make changes as required at the discretion of Gold Medal Products Company without notice.

INSTALLATION INSTRUCTIONS

INSTALLATION

Your new 6 oz. popcorn machine is completely assembled. Remove all Packing material and tape before starting operation.

OPERATING INSTRUCTIONS

CONTROLS AND THEIR FUNCTIONS

There are three switches on the popper.

LIGHT AND WARMER SWITCH

Turns on the heat to the bottom corn pan and heat light.

KETTLE MOTOR SWITCH

Turns on the motor which drives kettle agitator shaft.

KETTLE HEAT SWITCH

Turns on the heat element

AMOUNT OF POPCORN AND OIL

Your new popper is equipped with a six ounce (177 ml) corn measure cup. We recommend flavored and colored coconut oil. Popcorn popped in coconut oil stays fresh longer. Coconut oil does not leave black deposits in your kettle like other oils.

Corn charge - 6 oz. (177 ml)

Oil charge - 1.6 to 2.0 oz. (60 ml)

Flavacol - 1 tablespoon (8 cc)

POPPING INSTRUCTIONS



1. Turn KETTLE HEAT and KETTLE MOTOR switch ON.
2. Make test pop by putting 3 kernels of corn and 1 oz. (30 ml) of oil into the kettle.
3. When the 3 kernels have popped, load kettle with corn and oil charge.
4. When corn has popped, dump kettle.
5. Repeat cycle starting with Item #3; always pop 3-5 batches for best popcorn.

CARE AND CLEANING

	⚠ WARNING
	Unplug your machine before cleaning glass panels or case. Never immerse the kettle in water, this will ruin the electrical components and automatically void the warranty.

Each time you finish a series of poppings, allow the kettle to cool down, and wipe the outside of the kettle with a soft cloth to remove any oil drippage on the outside of the kettle. After you finish popping for the day, allow kettle to cool until it is not too hot to handle, but still warm. Unplug kettle and remove it from the machine. With a cloth, wipe out the inside of the kettle, kettle lid, crossbar, outside and underneath of the kettle.

Cleaning the cabinet of your machine is easy. Take a clean cloth and wipe excess grease from the glass. Wipe the outside of the machine also.

NOTE: Never use a glass or plastic cleaner that contains ammonia. It will crack the plastic on the machine.

MAINTENANCE INSTRUCTIONS

	⚠ WARNING
	Do not immerse the kettle, warmer, or any other part of this equipment in water. Always unplug your machine before servicing.

	⚠ WARNING
	Adequate eye protection must be used when servicing this equipment to prevent the possibility of injury.

	⚠ CAUTION
	THE FOLLOWING SECTIONS OF THIS MANUAL ARE INTENDED ONLY FOR QUALIFIED SERVICE PERSONNEL WHO ARE FAMILIAR WITH ELECTRICAL EQUIPMENT. THESE ARE NOT INTENDED FOR THE OPERATOR.

ACCESSORIES

<u>Description</u>	<u>Part Number</u>
Shipping Carton	49026
Corn Measure Cup	49049
Scoop	2071
Flavacol Cup	47678
Rubber Crutch Tips	49123

ORDERING SPARE PARTS

1. Identify the desired part by checking it against the photos, illustrations, and/or the parts list.
2. When ordering, please include part number, part name, and quantity desired.
3. Please include your model name, machine serial number, and date of manufacture, (located on the machine nameplate) with your order.
4. Address all parts orders to:

Parts Department
Gold Medal Products Co.
10700 Medallion Drive
Cincinnati, Ohio 45241-4807

or, place orders at:

(513) 769-7676
Fax: (513) 769-8500
E-mail: info@gmpopcorn.com
Web Page: www.gmpopcorn.com

1871 Cabinet Assembly – Front View



2660 Cabinet Assembly – Front View



2661 Cabinet Assembly – Front View



1871 Cabinet Assembly – Rear View

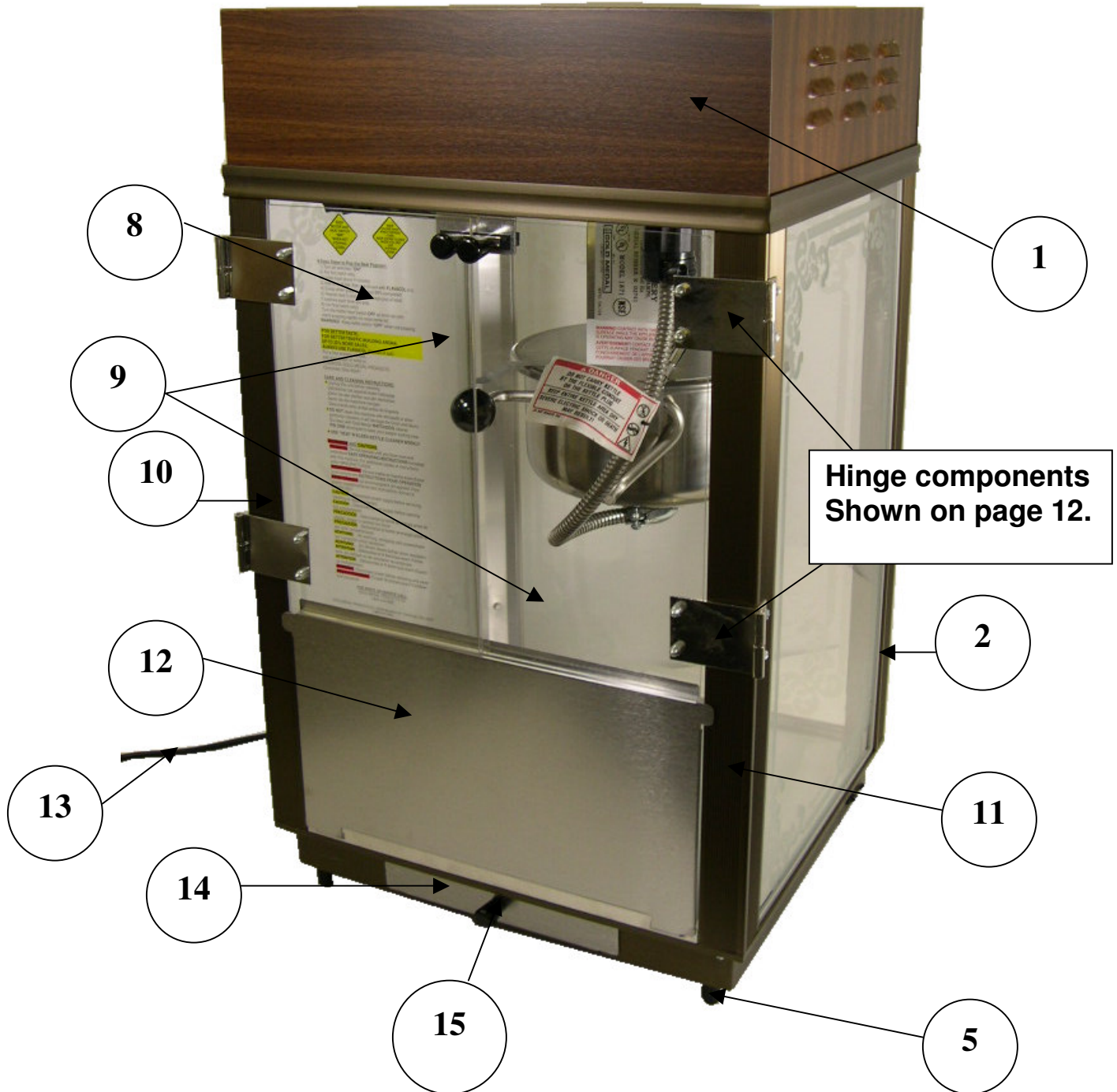

2660 Cabinet Assembly – Rear View

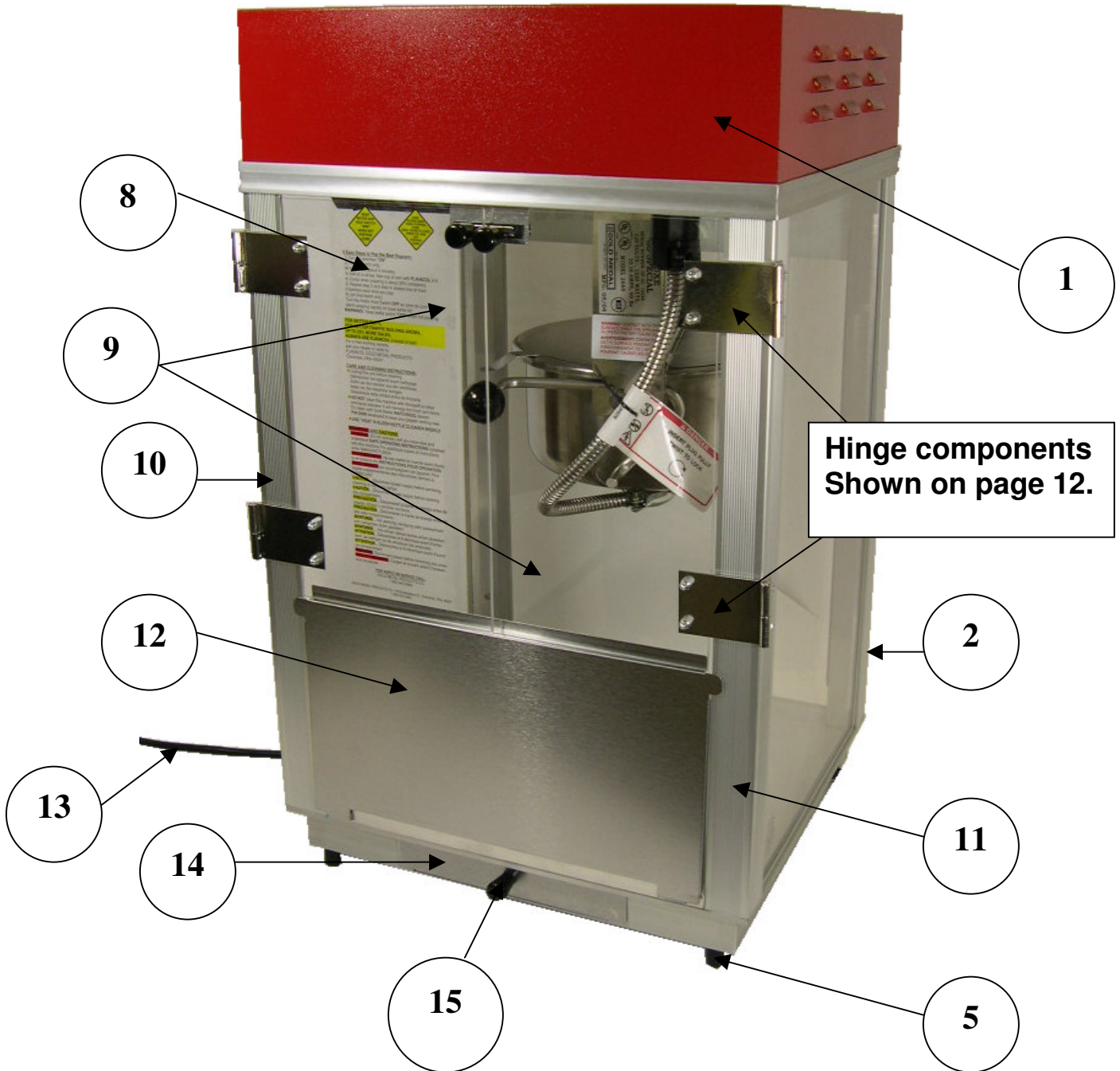

2661 Cabinet Assembly – Rear View

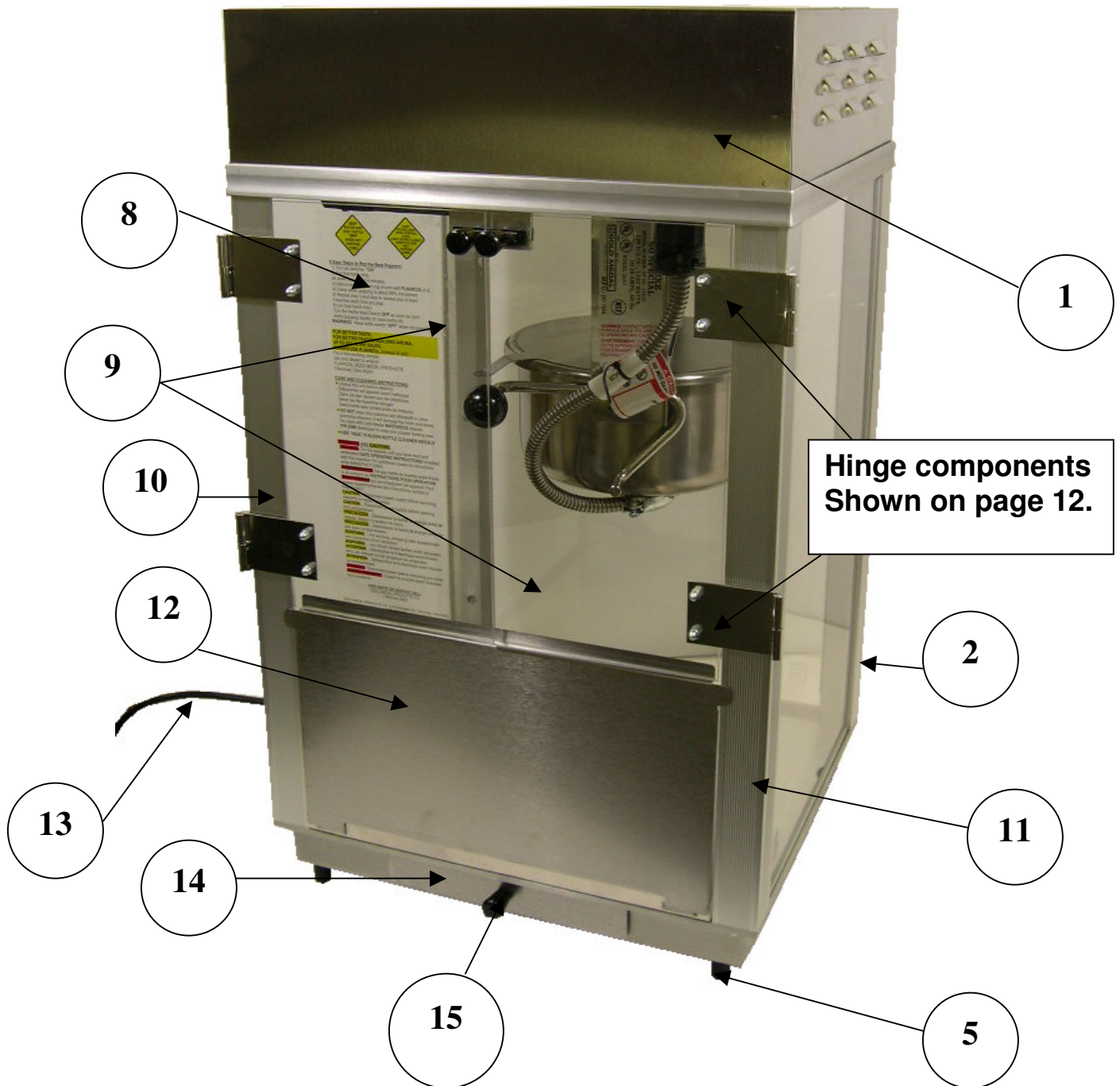

1871, 2660, 2661 Inside Cabinet – Top View

See diagram below for switch box assembly.

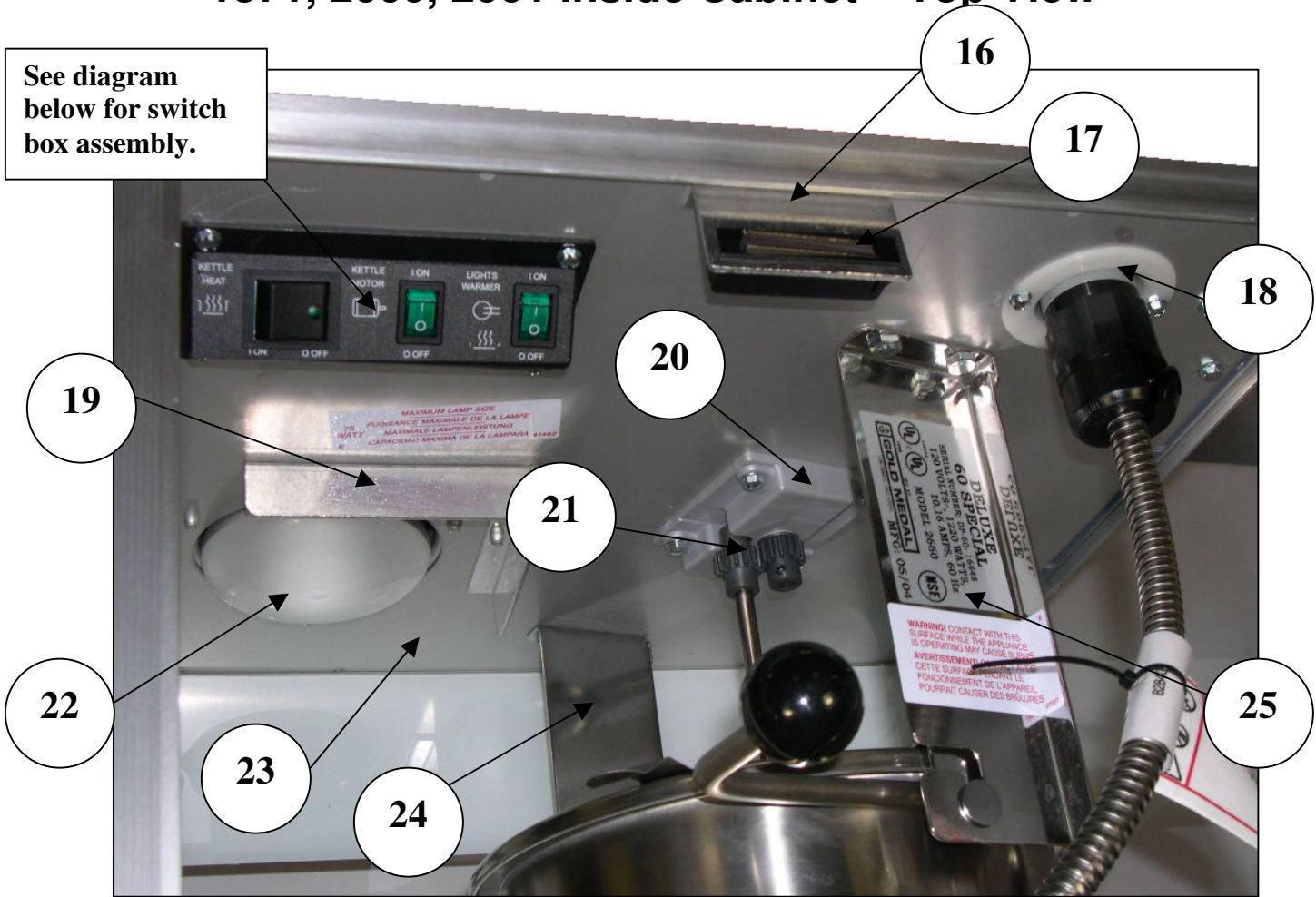

Operating Switches – Close up

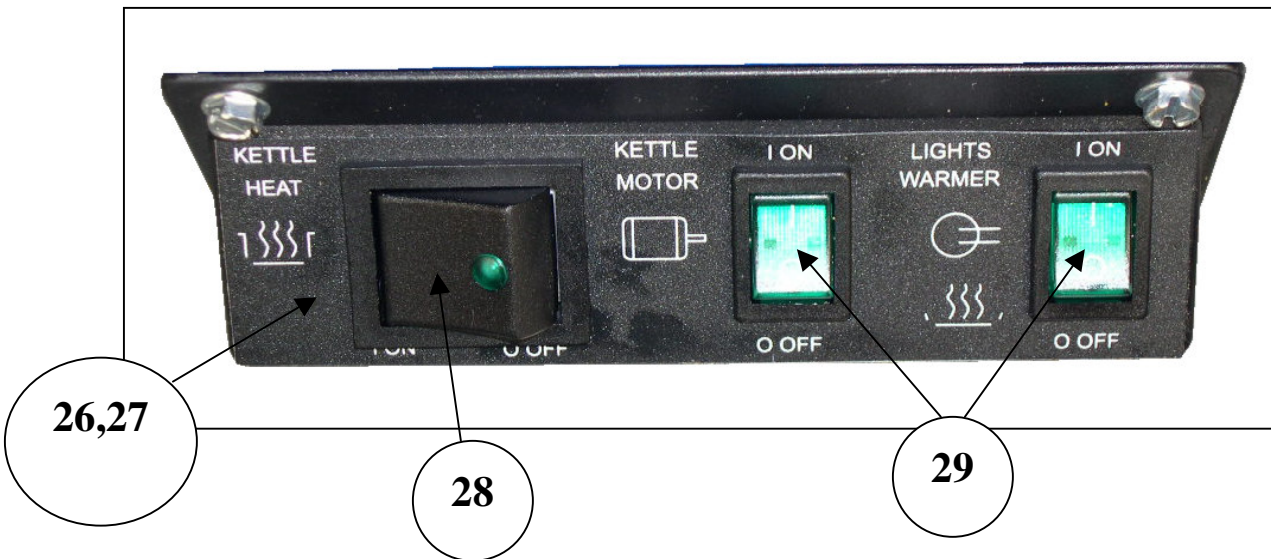

1871, 2660, 2661 Inside Cabinet – Bottom View

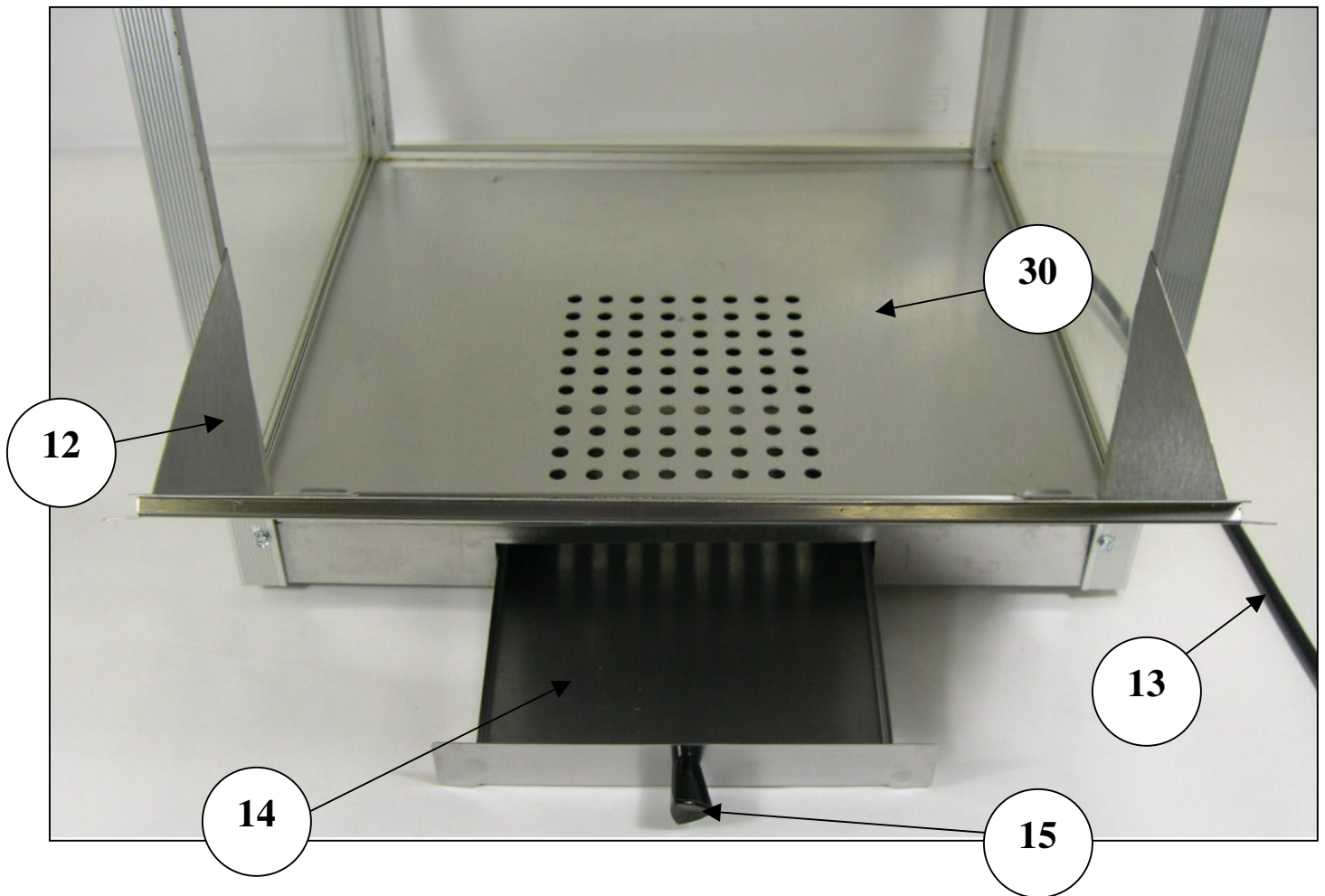

Warmer Assembly

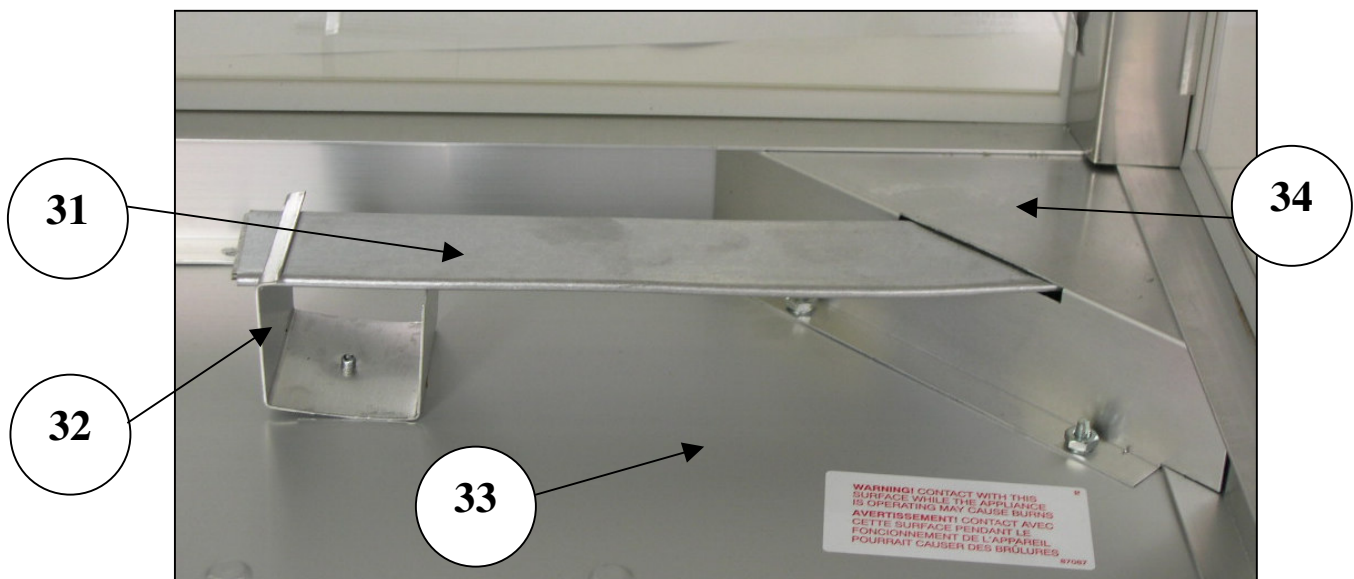

1871, 2660, 2661 Roof Components

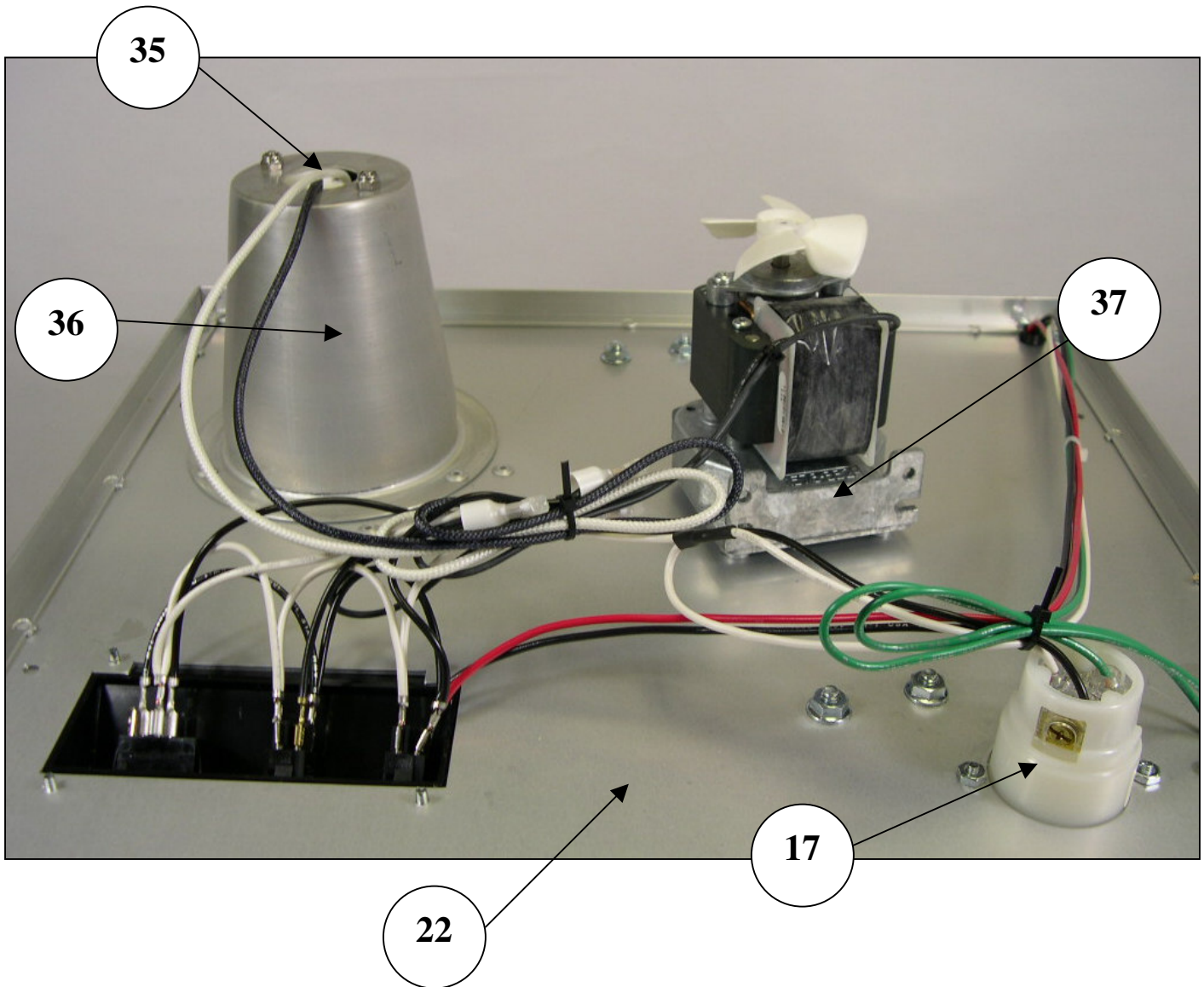

Door Hardware Kit – P/N 61380

The parts below are all included in kit part #61380,
but are also sold separately.

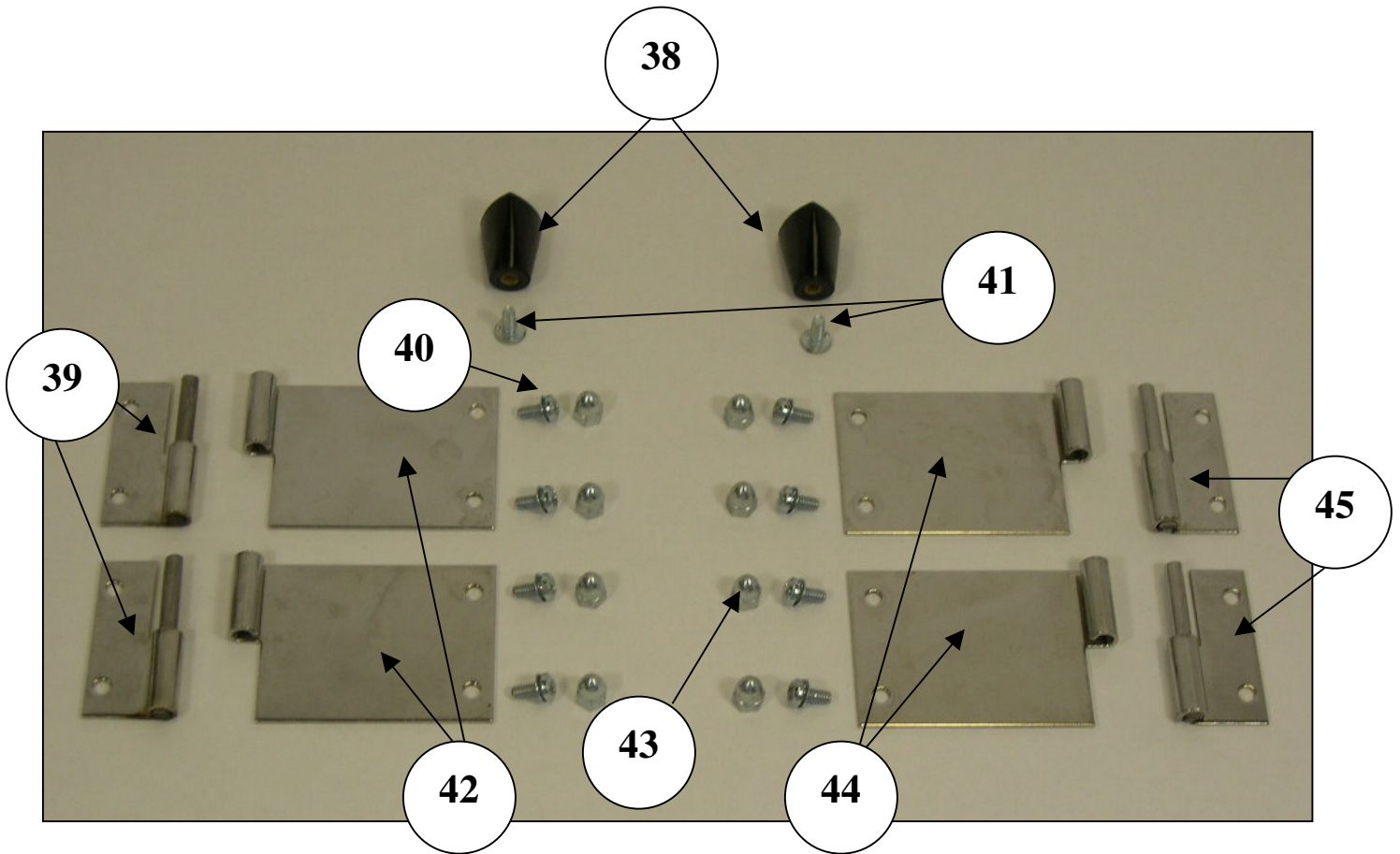

Parts List – Cabinet Assembly

Part Number

Item #	Model 1871	Model 2660	Model 2661	Description
1	49454	49456	48055	Dome
2	49247	49193	49193	Right Front Corner Post
3	49247	49193	49193	Left Front Corner Post
4	49246	49345	49345	Bottom Frame Assy.
5	47328	47328	47328	Glide
6		49158		Decal-Front Glass
7			49575	Popcorn Sign
8	41019	41019	41019	Door Decal
9	49396	49396	49396	Door
10	49249	49347	49347	Left Rear Corner Post
11	49248	49348	49348	Right Rear Corner Post
12	49210	49210	49210	Drop Panel
13	22038	22038	22038	Lead-in Cord
14	49100	49100	49100	Old Maid Pan
15	47120	47120	47120	Knob
16	77089	77089	77089	Magnetic Catch Brkt.
17	47561	47561	47561	Magnetic Catch
18	49330	49330	49330	Kettle Receptacle
19	47799	47799	47799	Light Shield Angle
20	67194NM	67194NM	67194NM	Gear Block
21	47060	47060	47060	Spur Gear
22	41671	41671	41671	75W Flood Lamp
23	49507	49507	49507	Motor Plate
24	49010	49010	49010	Front Hanger Arm
25	49009	49009	49009	Rear Hanger Arm
26	48501	48501	48501	Small Switch Box
27	48502	48502	48502	Switch Box Label
28	42798	42798	42798	Large Lighted Rocker
29	42532	42532	42532	Small Lighted Rocker
30	49211	49211	49211	Corn Pan
31	40031	40031	40031	50W Strip Heater
32	49103	49103	49103	Strip Heater Bracket
33	49202	49202	49202	Bottom Pan
34	49201	49201	49201	Wiring Guard
35	47047	47047	47047	Lamp Holder
36	49480	49480	49480	Light Shield Conicle
37	47038	47038	47038	Kettle Drive Motor
38	47120	47120	47120	Knob
39	41349	41349	41349	Left Male Hinge
40	42227	42227	42227	8-32 X 3/8" Screws
41	75267	75267	75267	Tee Bolts
42	61359	61359	61359	Left Female Hinge
43	47702	47702	47702	8-32 Acorn Nuts
44	61373	61373	61373	Right Female Hinge
45	41350	41350	41350	Right Male Hinge

6 oz. KETTLE ASSEMBLY

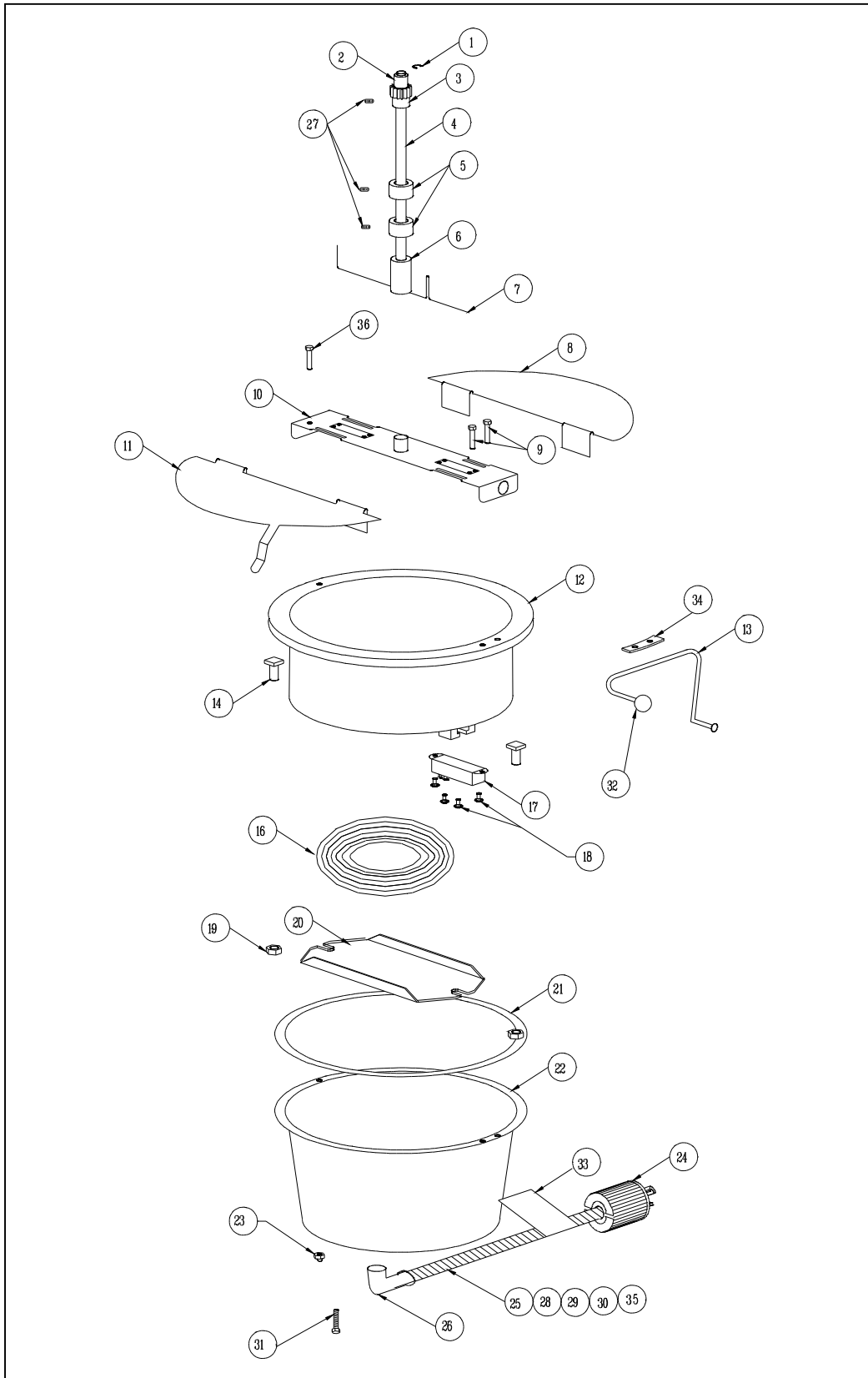

PARTS LIST – 6 oz. KETTLE ASSEMBLY

Models: 1871, 2660, 2661

Item No.	Part No.	Description
	49434	6 Oz. Kettle Complete
	49435	6 Oz. Lid & Agitator Assembly
	49433	6 Oz. Kettle Bottom Only
1	49701	External Snap Ring
2	47106	Needle Bearing
3	47060	Spur Gear
4	49437	Agitator Shaft Assembly
5	46649	Set Collar
6	49013	Agitator Weight
7	49011	Stir Rod
8	49016	Rear Kettle Lid
9	49592	#8-32 x 1 1/8" Screws
10	49471	Crossbar Assembly
11	49017	Front Lid With Lifter
12	49432	Kettle Welded Assembly
13	49314	Dump Handle RH
14	49446	Bolt 5 /16 -18 x 5 /8 " Square HD
16	46652	Heat Element 850W
17	47676	Thermostat
18	49136	Screw #6-32 x 3 /16 " Pan HD MS SS
19	74135	5 /16 -18 Nut
20	49532	Element Retainer Bracket
21	49368	Kettle Gasket
22	49431	Kettle Shell
23	47702	Acorn Nut #8-32
24	49329	Kettle Plug
25	77079-16	Flexible Conduit
26	46241	90 Degree Connector
28	49086	Red Kettle Wire Assembly
29	49087	White Kettle Wire Assembly
30	49159	Green Kettle Wire Assembly
31	49376	Screw #10-32 x 1"
32	47110	Knob, Dump Handle
33	49350	Caution Label
34	49362	Dump Handle Spacer
35	77080NM	Bushing, Conduit
36	49593	#8-32 x 5/8" Screw
	49328	Kettle Lead-In Cord Assembly Complete *

* Includes Item No. 24-26, 28-31, 33, and 35

ELECTRICAL SCHEMATIC

Models: 1871, 2660, 2661

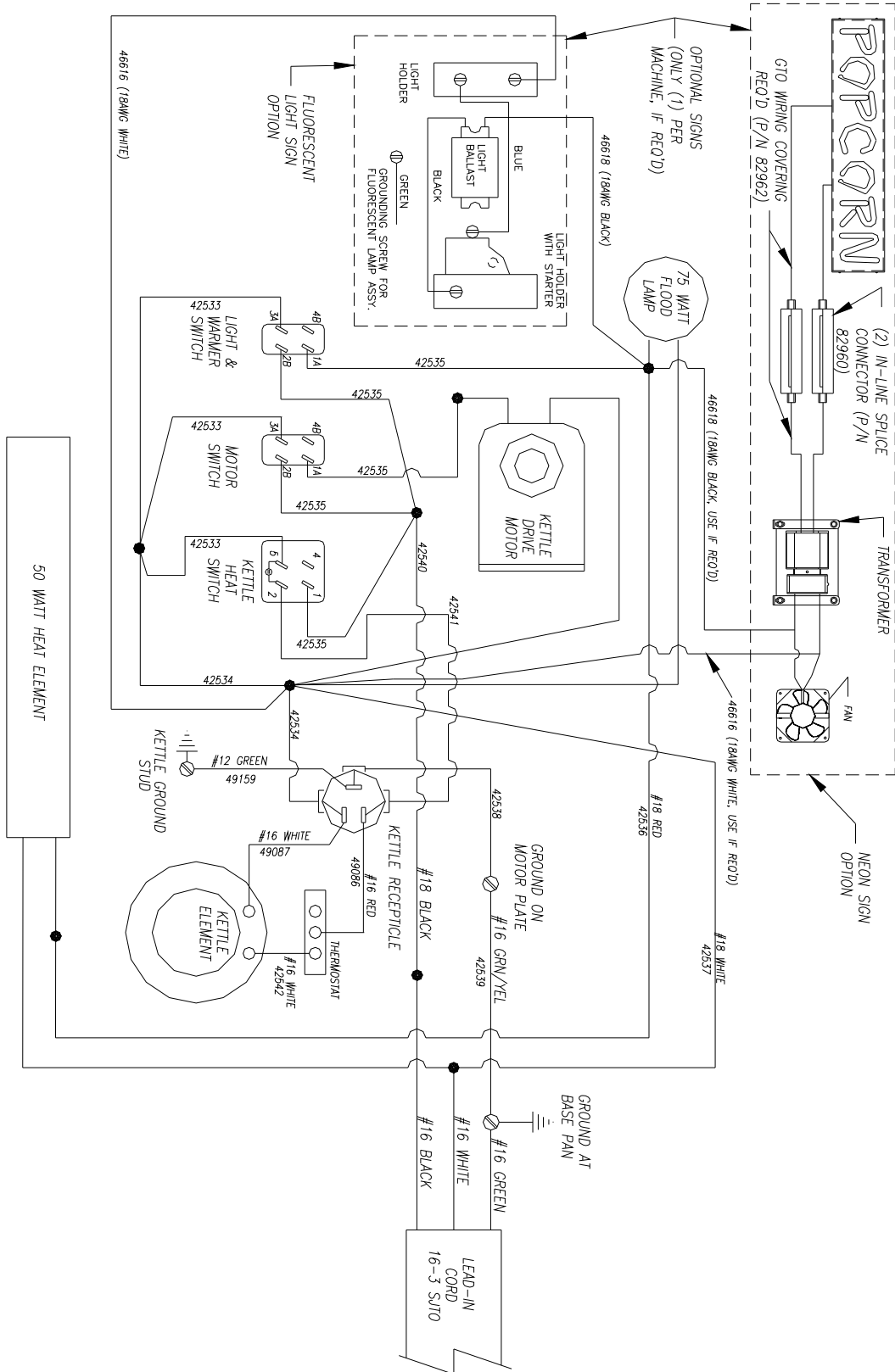

WARRANTY

WE WARRANT to the original purchaser the Gold Medal equipment sold by us to be free from defects in material or workmanship under normal use and service. Our obligation under this warranty shall be limited to the repair or replacement of any defective part for a period of six (6) months from the date of sale to the Original Purchaser with regard to labor and two (2) years with regard to parts and does not cover damage to the equipment caused by accident, alteration, improper use, voltage, abuse, or failure to follow instructions.

THIS WARRANTY IS IN LIEU OF ALL OTHER WARRANTIES EXPRESSED OR IMPLIED, AND OF ALL OTHER OBLIGATIONS OR LIABILITIES ON OUR PART, INCLUDING THE IMPLIED WARRANTY OF MERCHANTABILITY. THERE ARE NO WARRANTIES WHICH EXTEND BEYOND THE DESCRIPTION ON THE FACE HEREOF. We neither assume, nor authorize any other person to assume for us, any other obligation or liability in connection with the sale of said GOLD MEDAL equipment or any part thereof.

The term "Original Purchaser" as used in this warranty shall be deemed to mean that person, firm, association, or corporation who was billed by the GOLD MEDAL PRODUCTS COMPANY, or their authorized distributor for the equipment.

THIS WARRANTY HAS NO EFFECT AND IS VOID UNLESS THE ORIGINAL PURCHASER FIRST CALLS GOLD MEDAL PRODUCTS COMPANY AT 1-800-543-0862 TO DISCUSS WITH OUR SERVICE REPRESENTATIVE THE EQUIPMENT PROBLEM, AND, IF NECESSARY, FOR INSTRUCTIONS CONCERNING THE REPAIR OR REPLACEMENT OF PARTS.

NOTE: This equipment is manufactured and sold for commercial use only.



GOLD MEDAL PRODUCTS COMPANY

10700 Medallion Drive

Cincinnati, Ohio 45241-4807 USA

www.gmpopcorn.com

Phone: 1-800-543-0862

Fax: 1-800-542-1496